

TYPE 12 JIC PULL THRU WIREWAY

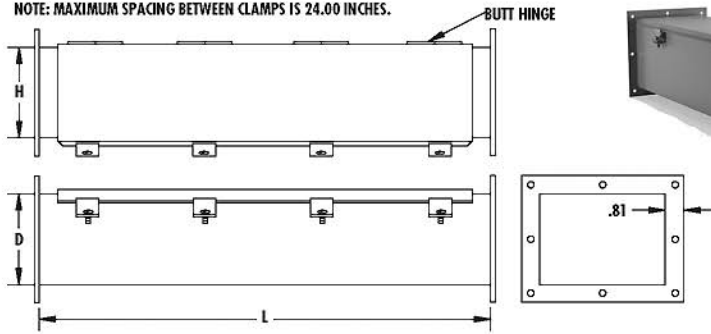

NOTE: MAXIMUM SPACING BETWEEN CLAMPS IS 24.00 INCHES.



TYPE 12 PULL THROUGH WIREWAY



CONSTRUCTION:

- CODE GAUGE PAINT GRIP GALVANIZED STEEL
- 12 GAUGE STEEL END FLANGES
- SEAMS CONTINUOUSLY WELDED AND GROUND SMOOTH
- BUTT HINGES
- SCREW CLAMPS ARE QUICK AND EASY TO OPERATE
- OIL RESISTANT GASKET
- GASKET POSITIONED BETWEEN FLANGES WHEN SECTIONS AND FITTINGS ARE BOLTED TOGETHER

FINISH:

- ANSI 61 GRAY POLYESTER POWDER COATING INSIDE AND OUT

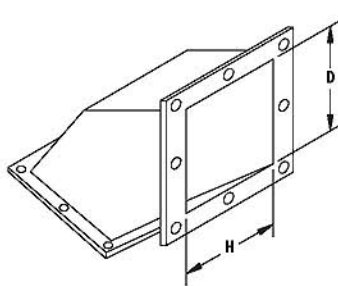

45 ELBOW

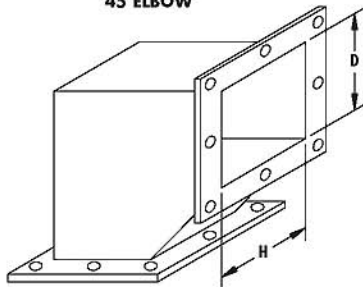

90 ELBOW

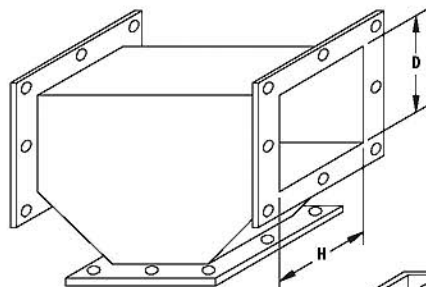

TEE

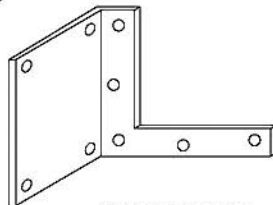

BRACKET HANGER

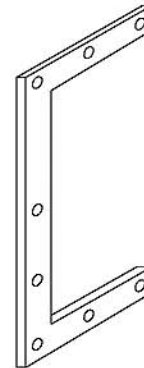
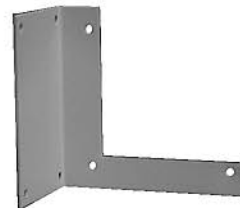

DROP HANGER

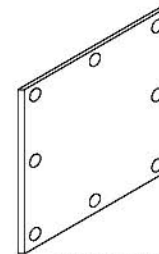
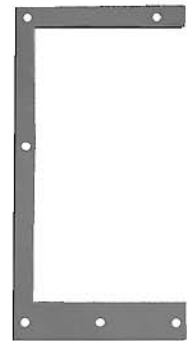

END PLATE

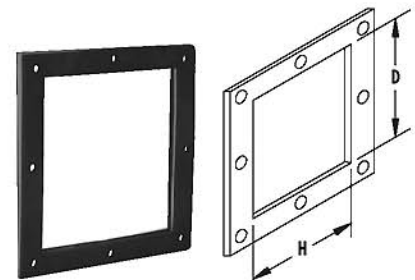

BOX CONNECTOR



Wireway Size HxDxL	Catalog Number	Weight
4x4x12	1-44P	6
4x4x24	2-44P	11
4x4x36	3-44P	16
4x4x48	4-44P	21
4x4x60	5-44P	25
4x4x120	10-44P	55

Continue on next Page

TYPE 12



TYPE 12 JIC PULL THRU WIREWAY

	Catalog Number	Weight
4' FITTINGS		
90L	4-90P	5
45L	4-45P	4
Cross	4-CP	8
Tees	4-TPN12	6
End Plate	4-EPP	1
Cut-Off	4-CFP	6
1" Nipple	4-NIP	2
2" Nipple	4-N2P	2
3" Nipple	4-N3P	3
Box Connector	4-BCP	1
Reducer	4-RPN12	1
Drop Hanger	4-DHP	1
Bracket Hanger	4-BHP	1
WIREWAY SIZE HxDxL	Catalog Number	Weight
6x6x12	1-66P	9
6x6x24	2-66P	16
6x6x36	3-66P	24
6x6x48	4-66P	29
6x6x60	5-66P	37
6x6x120	10-66P	76
6' FITTINGS		
90L	6-90P	8
45L	6-45P	5
Cross	6-CP	11
Tees	6-TPN12	10
End Plate	6-EPP	3
Cut-Off	6-CFP	8
1" Nipple	6-NIP	3
2" Nipple	6-N2P	4
3" Nipple	6-N3P	4
Box Connector	6-BCP	1
Reducer	6-RPN12	2
Drop Hanger	6-DHP	2
Bracket Hanger	6-BHP	2
WIREWAY SIZE HxDxL	Catalog Number	Weight
8x8x12	1-88P	12
8x8x24	2-88P	21
8x8x36	3-88P	29
8x8x48	4-88P	39
8x8x60	5-88P	49
8x8x120	10-88P	78
8" FITTINGS		
90L	8-90P	12
45L	8-45P	7
Cross	8-CP	16
Tee	8-TPN12	14
End Plate	8-EPP	4
Cut-Off	8-CFP	11
1" Nipple	8-NIP	4
2" Nipple	8-N2P	4
3" Nipple	8-N3P	4
Box Connector	8-BCP	2
Reducer	8-RPN12	3
Drop Hanger	8-DHP	7
Bracket Hanger	8-BHP	4

FOR LARGE QUANTITIES CALL FACTORY

TYPE 12